

GUYED TOWERS

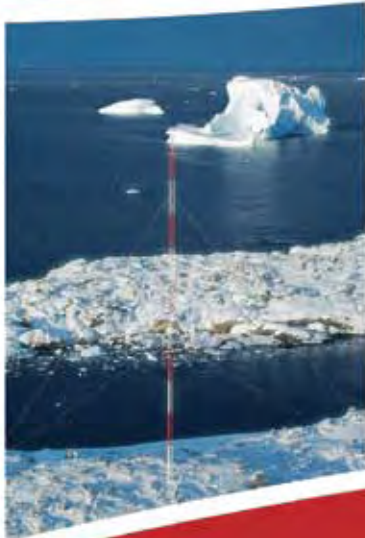



STANDARD 65G GUYED TOWER

ROHN 65G
The first. The original.

65G

GENERAL USE

The 65G is designed to provide excellent rigidity and strength in applications up to 500' when guyed, and 80' when self-supporting. This high strength design covers a wide variety of communications uses. The 65G is completely prefabricated in welded sections allowing for quick and convenient installation

DESIGN

- Tower sections and all hardware are completely hot-dip galvanized after fabrication
- Utilizes 1.5" O.D. high strength steel side rails
- Built on 26 1/4" equilateral triangle design
- Zig-Zag® cross bracing is formed from a continuous 5/8" steel rod
- Completely prefabricated in welded sections

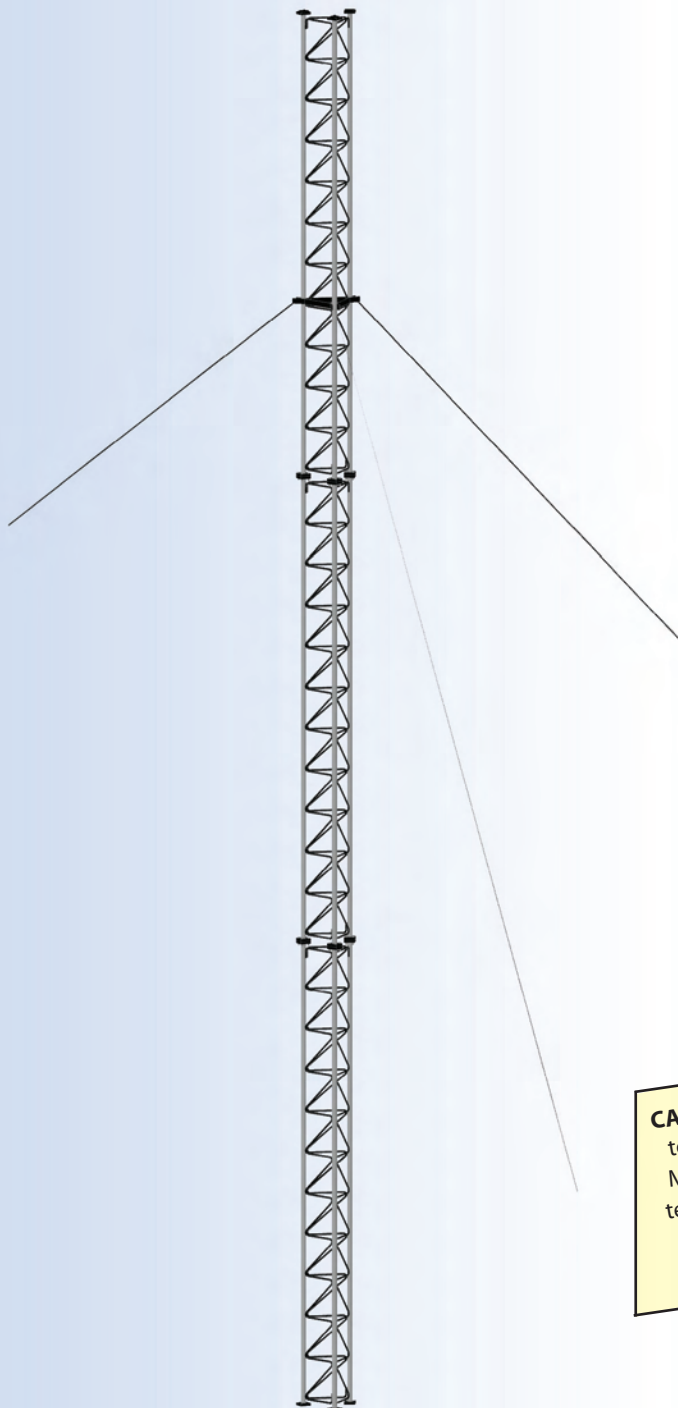

CAUTION: the mixing of so-called interchangeable copies of ROHN towers with ROHN towers is dangerous and voids all engineering or warranty data supplied by ROHN. Materials used by the so-called copies are not the same quality and have not been tested or engineered by ROHN to conform to the same quality standards. Mixing of ROHN items may endanger the lives of your customers and cause serious tower failures and financial misfortune for all concerned.

STANDARD 65G GUYED TOWER SECTIONS

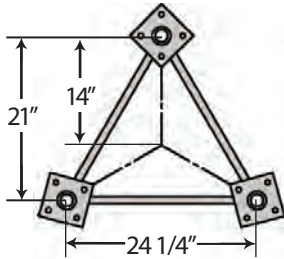

QUICK REFERENCE

PARTS & ACCESSORIES	PAGE 90
FOUNDATION INFORMATION	PAGE 91
GROUNDING INFORMATION	PAGE 92

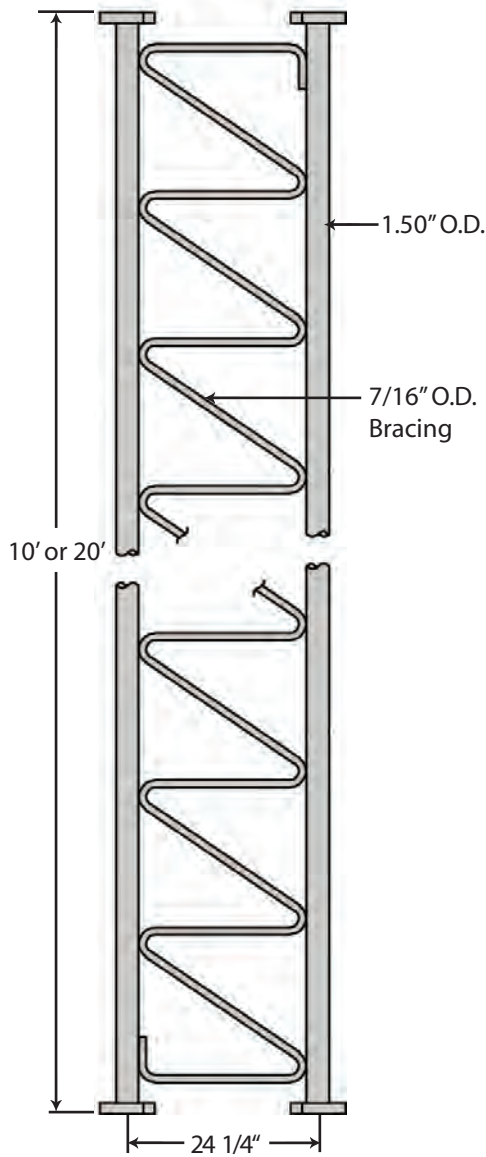

STANDARD SECTION
65G - 10' Section
65G20 - 20' Section

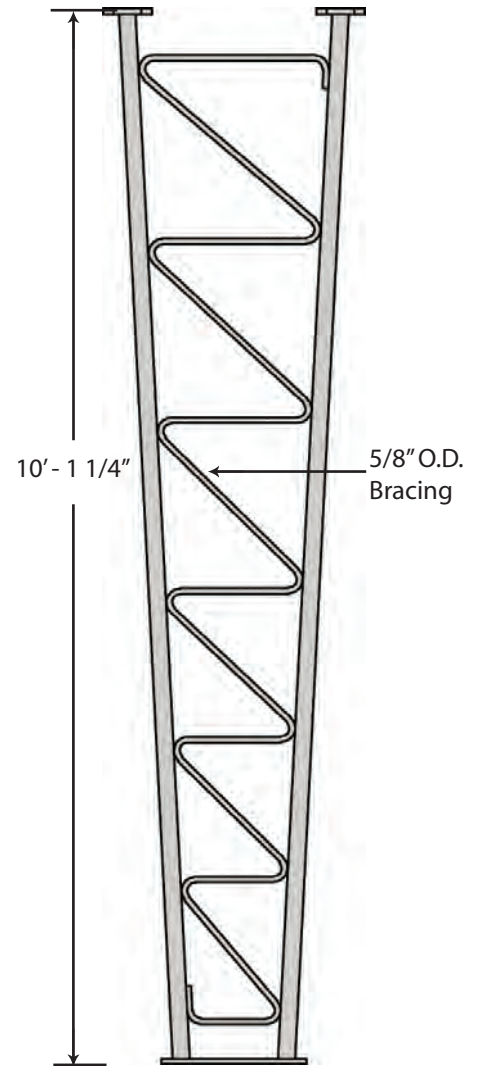

TAPERED BASE
65TGH



**STANDARD DESIGN - 65G
70MPH REV. F**

All tower kits include the following: all necessary tower sections, all guy wire and connectors, all guy anchors and base and anchor ground kits.

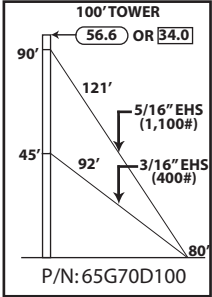

100' ROHN 65G
Part No: 65G70D100
Base: CB1
Anchor: 4B
Rod: GAC3455TOP

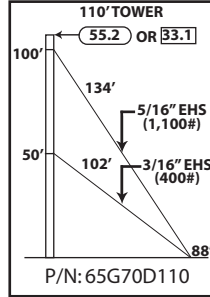

110' ROHN 65G
Part No: 65G70D110
Base: CB1
Anchor: 4B
Rod: GAC3455TOP

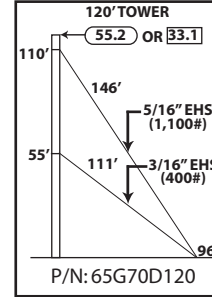

120' ROHN 65G
Part No: 65G70D120
Base: CB1
Anchor: 4B
Rod: GAC3455TOP

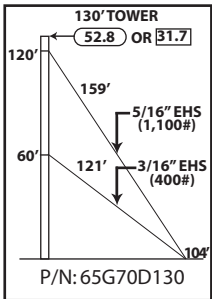

130' ROHN 65G
Part No: 65G70D130
Base: CB1
Anchor: 4B
Rod: GAC3455TOP

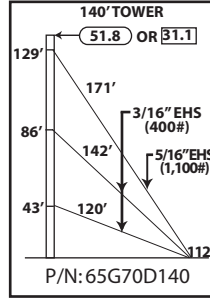

140' ROHN 65G
Part No: 65G70D140
Base: CB1
Anchor: 4C
Rod: GAC3455TOP

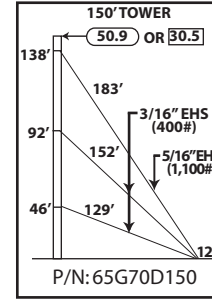

150' ROHN 65G
Part No: 65G70D150
Base: CB1
Anchor: 4C
Rod: GAC3455TOP

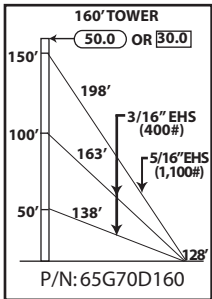

160' ROHN 65G
Part No: 65G70D160
Base: CB1
Anchor: 4C
Rod: GAC3455TOP

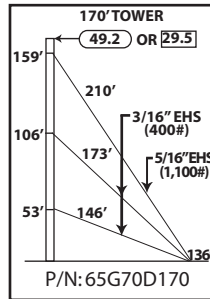

170' ROHN 65G
Part No: 65G70D170
Base: CB1
Anchor: 4C
Rod: GAC3455TOP

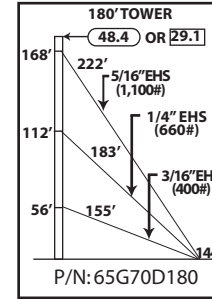

180' ROHN 65G
Part No: 65G70D180
Base: CB1
Anchor: 4D
Rod: GAC3455TOP

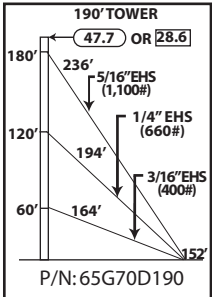

190' ROHN 65G
Part No: 65G70D190
Base: CB2
Anchor: 4D
Rod: GAC3455TOP

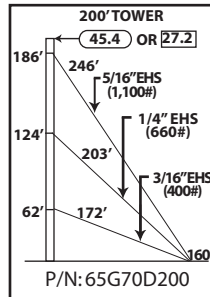

200' ROHN 65G
Part No: 65G70D200
Base: CB2
Anchor: 4D
Rod: GAC3455TOP

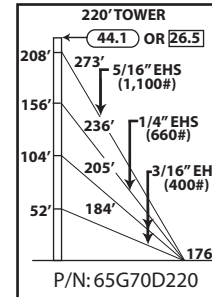

220' ROHN 65G
Part No: 65G70D220
Base: CB2
Anchor: 4D
Rod: GAC3455TOP

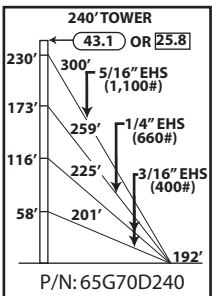

240' ROHN 65G
Part No: 65G70D240
Base: CB2
Anchor: 4E
Rod: GAC3455TOP

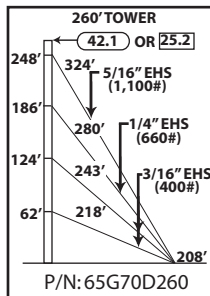

260' ROHN 65G
Part No: 65G70D260
Base: CB2
Anchor: 4E
Rod: GAC3455TOP

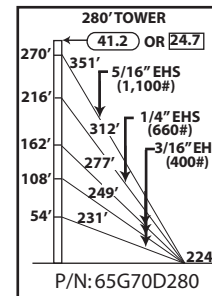

280' ROHN 65G
Part No: 65G70D280
Base: CB2
Anchor: 4E
Rod: GAC3455TOP

STANDARD DESIGN - 65G

70MPH REV. F

All tower kits include the following: all necessary tower sections, all guy wire and connectors, all guy anchors and base and anchor ground kits.

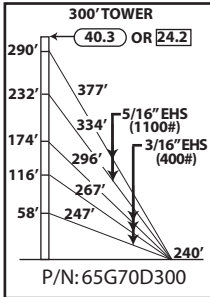

300' ROHN 65G
 Part No: 65G70D300
 Base: CB2
 Anchor: 6A
 Rod: GAC5655TOP

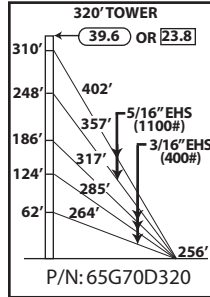

320' ROHN 65G
 Part No: 65G70D320
 Base: CB3
 Anchor: 6A
 Rod: GAC5655TOP

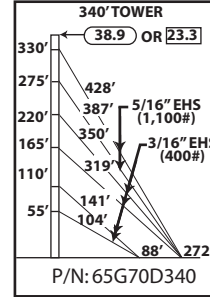

340' ROHN 65G
 Part No: 65G70D340
 Base: CB4
 Inner Anchor: 4A
 Inner Rod: GAC303
 Outer Anchor: 6A
 Outer Rod: GAC5655TOP

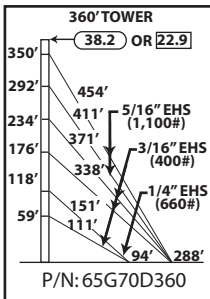

360' ROHN 65G
 Part No: 65G70D360
 Base: CB3
 Inner Anchor: 4A
 Inner Rod: GAC303
 Outer Anchor: 6A
 Outer Rod: GAC5655TOP

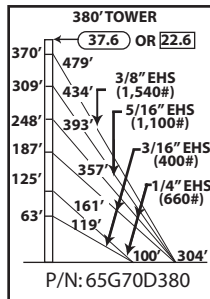

380' ROHN 65G
 Part No: 65G70D380
 Base: CB3
 Inner Anchor: 4A
 Inner Rod: GAC303
 Outer Anchor: 6A
 Outer Rod: GAC5655TOP

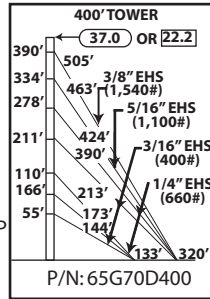

400' ROHN 65G
 Part No: 65G70D400
 Base: CB4
 Inner Anchor: 4A
 Inner Rod: GAC3455TOP
 Outer Anchor: 6A
 Outer Rod: GAC5655TOP

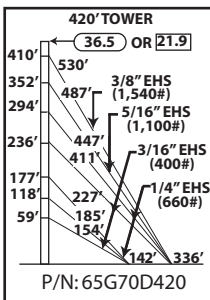

420' ROHN 65G
 Part No: 65G70D420
 Base: CB4
 Inner Anchor: 4B
 Inner Rod: GAC3455TOP
 Outer Anchor: 6B
 Outer Rod: GAC5655TOP

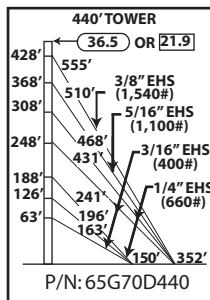

440' ROHN 65G
 Part No: 65G70D440
 Base: CB4
 Inner Anchor: 4B
 Inner Rod: GAC3455TOP
 Outer Anchor: 6B
 Outer Rod: GAC5655TOP

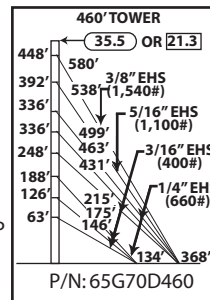

460' ROHN 65G
 Part No: 65G70D460
 Base: CB4
 Inner Anchor: 4A
 Inner Rod: GAC303
 Outer Anchor: 6C
 Outer Rod: GAC5655TOP

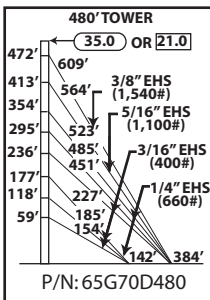

480' ROHN 65G
 Part No: 65G70D480
 Base: CB4
 Inner Anchor: 4B
 Inner Rod: GAC3455TOP
 Outer Anchor: 6C
 Outer Rod: GAC5655TOP

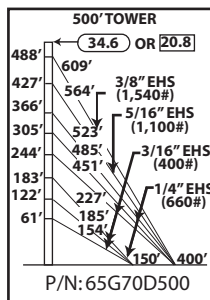

500' ROHN 65G
 Part No: 65G70D500
 Base: CB4
 Inner Anchor: 4B
 Inner Rod: GAC3455TOP
 Outer Anchor: 6D
 Outer Rod: GAC5655TOP



STANDARD DESIGN - 65G
90MPH REV. F

All tower kits include the following: all necessary tower sections, all guy wire and connectors, all guy anchors and base and anchor ground kits.

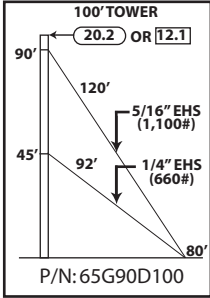

100' ROHN 65G
Part No: 65G90D100
Base: CB1
Anchor: 4B
Rod: GAC3455TOP

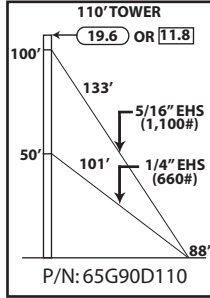

110' ROHN 65G
Part No: 65G90D110
Base: CB1
Anchor: 4B
Rod: GAC3455TOP

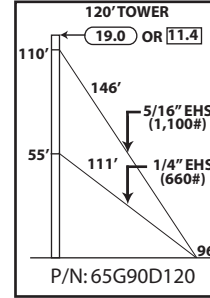

120' ROHN 65G
Part No: 65G90D120
Base: CB1
Anchor: 4C
Rod: GAC3455TOP

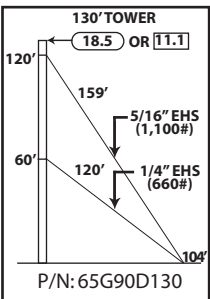

130' ROHN 65G
Part No: 65G90D130
Base: CB1
Anchor: 4C
Rod: GAC3455TOP

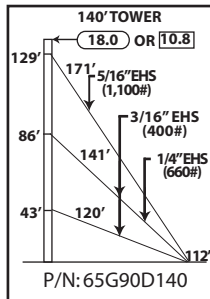

140' ROHN 65G
Part No: 65G90D140
Base: CB1
Anchor: 4D
Rod: GAC3455TOP

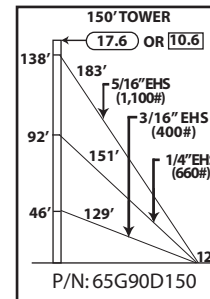

150' ROHN 65G
Part No: 65G90D150
Base: CB1
Anchor: 4D
Rod: GAC3455TOP

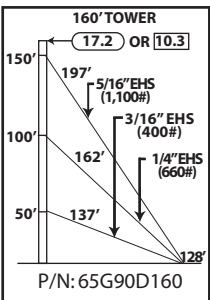

160' ROHN 65G
Part No: 65G90D160
Base: CB2
Anchor: 4D
Rod: GAC3455TOP

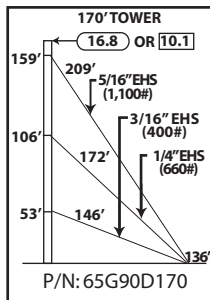

170' ROHN 65G
Part No: 65G90D170
Base: CB2
Anchor: 4D
Rod: GAC3455TOP

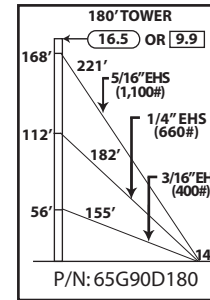

180' ROHN 65G
Part No: 65G90D180
Base: CB2
Anchor: 4E
Rod: GAC3455TOP

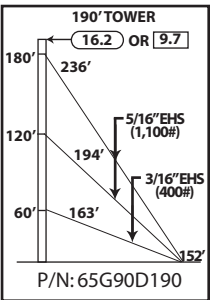

190' ROHN 65G
Part No: 65G90D190
Base: CB2
Anchor: 4E
Rod: GAC3455TOP

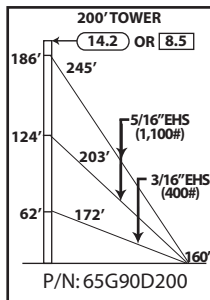

200' ROHN 65G
Part No: 65G90D200
Base: CB2
Anchor: 6A
Rod: GAC3455TOP

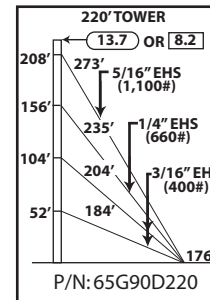

220' ROHN 65G
Part No: 65G90D220
Base: CB2
Anchor: 6A
Rod: GAC5655TOP

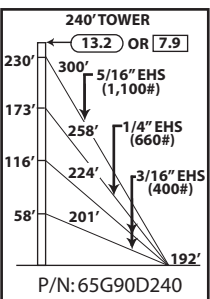

240' ROHN 65G
Part No: 65G90D240
Base: CB2
Anchor: 6A
Rod: GAC5655TOP

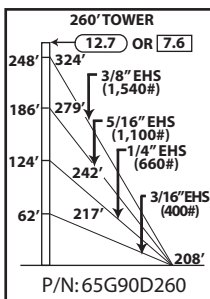

260' ROHN 65G
Part No: 65G90D260
Base: CB3
Anchor: 6A
Rod: GAC5655TOP

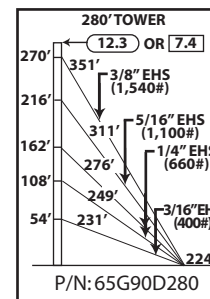

280' ROHN 65G
Part No: 65G90D280
Base: CB3
Anchor: 6B
Rod: GAC5655TOP

STANDARD DESIGN - 65G 90MPH REV. F

All tower kits include the following: all necessary tower sections, all guy wire and connectors, all guy anchors and base and anchor ground kits.

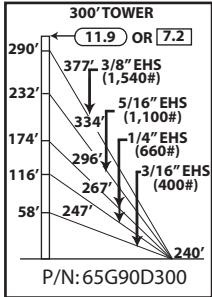

300' ROHN 65G
Part No: 65G90D300
Base: CB3
Anchor: 6C
Rod: GAC5655TOP

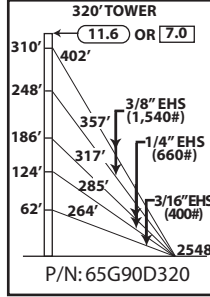

320' ROHN 65G
Part No: 65G90D320
Base: CB3
Anchor: 6C
Rod: GAC5655TOP

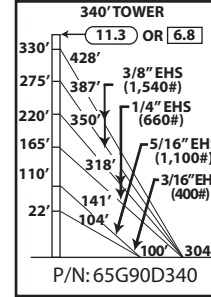

340' ROHN 65G
Part No: 65G90D340
Base: CB4
Inner Anchor: 4B
Inner Rod: GAC3455TOP
Outer Anchor: 6C
Outer Rod: GAC5655TOP



STANDARD DESIGN - 65G 110MPH REV. F

All tower kits include the following: all necessary tower sections, all guy wire and connectors, all guy anchors and base and anchor ground kits.

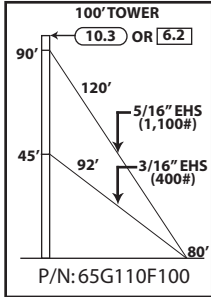

100' ROHN 65G
 Part No: 65G110F100
 Base: CB1
 Anchor: 4D
 Rod: GAC3455TOP

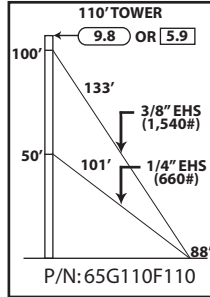

110' ROHN 65G
 Part No: 65G110F110
 Base: CB1
 Anchor: 4D
 Rod: GAC3455TOP

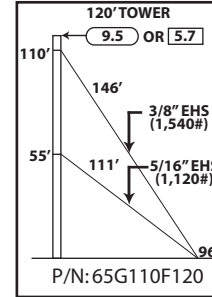

120' ROHN 65G
 Part No: 65G110F120
 Base: CB2
 Anchor: 4E
 Rod: GAC3455TOP

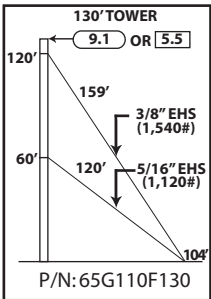

130' ROHN 65G
 Part No: 65G110F130
 Base: CB2
 Anchor: 4E
 Rod: GAC3455TOP

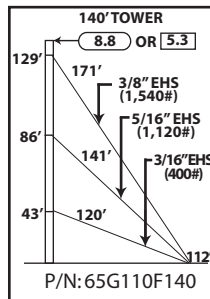

140' ROHN 65G
 Part No: 65G110F140
 Base: CB2
 Anchor: 4E
 Rod: GAC3455TOP

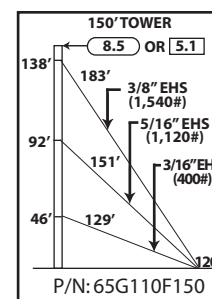

150' ROHN 65G
 Part No: 65G110F150
 Base: CB2
 Anchor: 6E
 Rod: GAC5655TOP

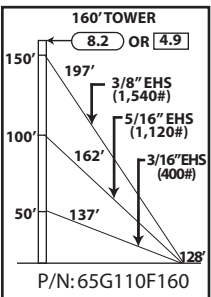

160' ROHN 65G
 Part No: 65G110F160
 Base: CB2
 Anchor: 6A
 Rod: GAC5655TOP

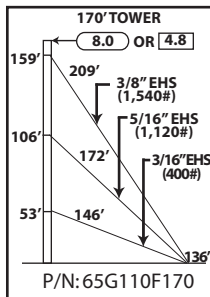

170' ROHN 65G
 Part No: 65G110F170
 Base: CB2
 Anchor: 6A
 Rod: GAC5655TOP

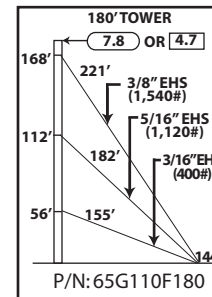

180' ROHN 65G
 Part No: 65G110F180
 Base: CB2
 Anchor: 6A
 Rod: GAC5655TOP

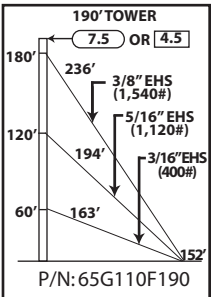

190' ROHN 65G
 Part No: 65G110F190
 Base: CB2
 Anchor: 6A
 Rod: GAC5655TOP

PARTS & ACCESSORIES

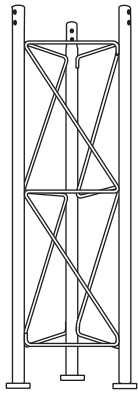

5' SHORT BASE
SB65G
FOR CONCRETE.

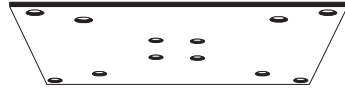

BEACON PLATE
APL4HA
LEG MOUNTED & (2) CAP PLATES
WITH NUTS & BOLTS

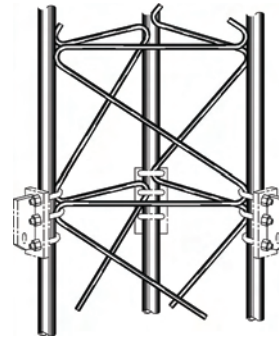

GUY BRACKET ASSEMBLY
GA65GD
LEG MOUNTED & (2) CAP PLATES
WITH NUTS & BOLTS

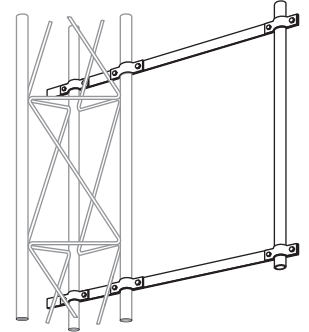

SIDE ARM ASSEMBLY
SA253UA
2 1/2' TO 3' EXTENSION, WITH 2 1/4" O.D.
SUPPORT TUBE.
KY1048A
6' SIDE ARM

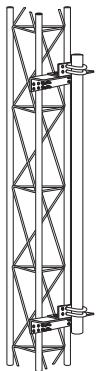

FACE DISH MOUNT
DM654
4" (4 1/2" O.D.) 5' PIPE.
DM654TB
4" (4 1/2" O.D.) 5' PIPE WITH TIE BACK
ANGLE.

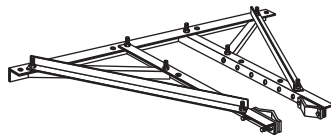

HOUSE BRACKET
KH1014

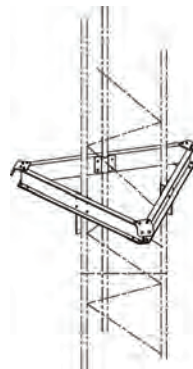

TORQUE ARM
TA656
AVAILABLE IN 6" OR 8"

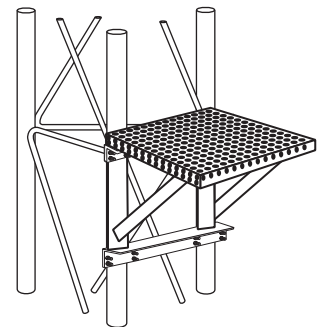

WORK PLATFORM
WPCC65



CLIMBING HARNESS
TTFBH-4D
4D RING HARNESS
TTFBH-C/P
PROFESSIONAL HARNESS



SAFETY CABLE SLIDER
TT-WG-500
WIRE ROPE GRAB

SAFETY CABLE SYSTEM ORDERING INFORMATION

TOWER HEIGHT	PART NUMBER
50'	TT05065
100'	TT10065
150'	TT15065
200'	TT20065
250'	TT25065
300'	TT30065
350'	TT35065
400'	TT40065
450'	TT45065
500'	TT50065

STANDARD FOUNDATIONS

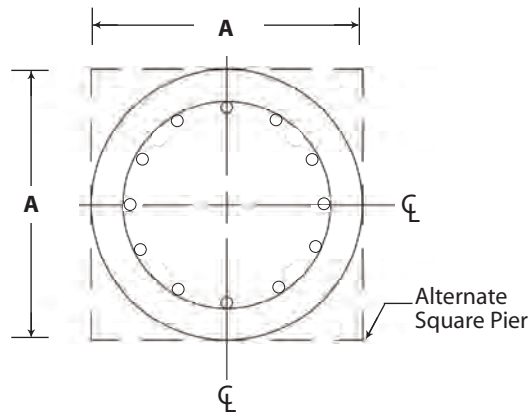
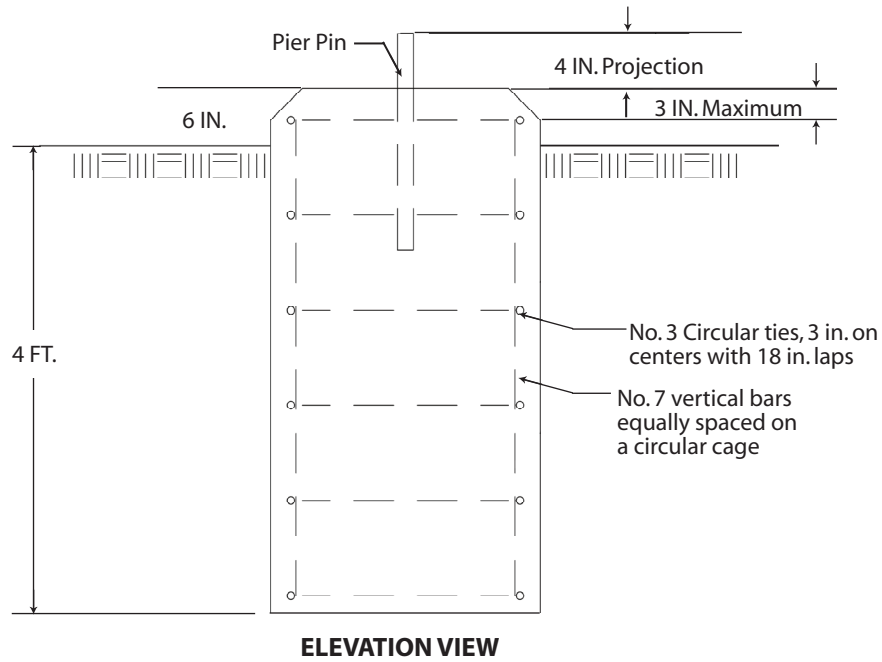

CB No.	A	Vertical Bars (Qty.)	Vertical Bars Circular Cage Diameter	Concrete Vol. (Cu. Yds.)
1	2' - 6"	8	21"	0.8
2	3'	10	27"	1.2
3	3' - 6"	12	33"	1.6
4	4'	12	39"	2.1

STANDARD DESIGN - 65G ANCHOR BLOCKS

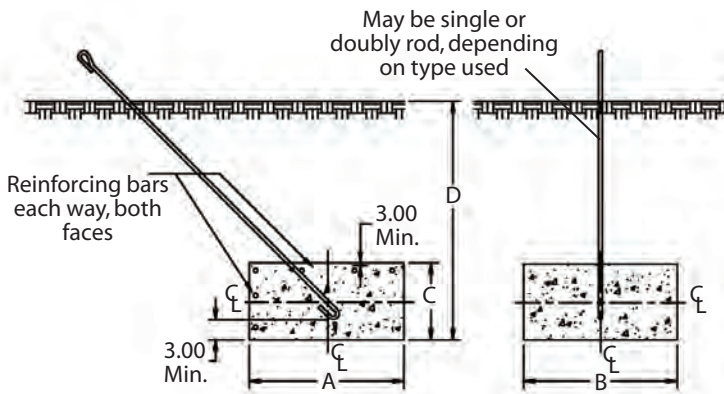

Anchor Detail for:
GAC34, 56, 57 & 58

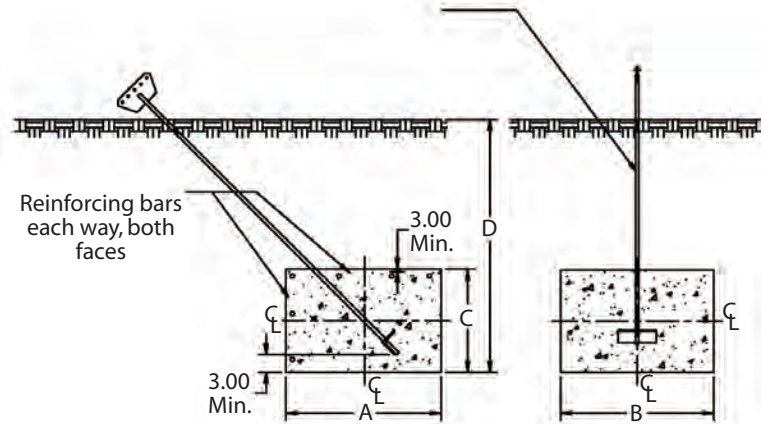

Anchor Detail for:
GAC30 & GAR30

Concrete Anchor Block Data							
Depth, D (ft.)	Rod No.	Block No.	Anchor Dimensions (in.)			Weight Concrete (lbs.)	Concrete (Cu. Yds.)
			A	B	C		
4	GAR30 GAC30 or GAC34	4A	36.00	36.00	18.00	1,890.00	0.50
		4B	36.00	48.00	18.00	2,520.00	0.67
		4C	36.00	60.00	18.00	3,150.00	0.84
		4D	36.00	72.00	18.00	3,780.00	1.00
		4E	48.00	72.00	18.00	5,050.00	1.33
6	GAC56	6A	36.00	48.00	18.00	2,520.00	0.67
		6B	36.00	60.00	18.00	3,150.00	0.84
		6C	36.00	72.00	18.00	3,780.00	1.00
		6D	48.00	72.00	18.00	5,050.00	1.33
8	GAC57	8A	36.00	60.00	18.00	3,150.00	0.84

NOTE:

1. Minimum 1/2" diameter reinforcing bars in all anchors with maximum spacing of 12".
2. Due to variables involved during installation, it shall be the customer or installers responsibility to provide structurally adequate supports for pier and anchor connections. It may also be necessary for the customer or installer to secure the service of a local engineer to determine that installation complies with local building codes.
3. Normal soil is a cohesive type soil with a horizontal bearing capacity of 400 lbs. per square foot per lineal foot of depth. Rock, non-cohesive soils or saturated or submerged soils are not to be considered as normal.